

RESEARCH ON THE INFLUENCE OF WORKPIECE ORIENTATION DURING PROCESSING IN DISC CENTRIFUGAL MACHINE ON THE GEOMETRICAL STRUCTURE OF ITS SURFACE AND PROCESSING EFFICIENCY

Jarosław Plichta^{1*}, Mateusz Juniewicz¹

^{1*} Faculty of Mechanical Engineering, Department of Production Engineering, Koszalin University of Technology, Raclawicka 15-17, 75-620 Koszalin, Poland, e-mail: jaroslaw.plichta@tu.koszalin.pl

(Received 10 September 2020, Accepted 21 September 2020)

Abstract: The article describes the result of experiments which were intended to compare the results of different workpieces orientation in disc centrifugal machine. During experimental investigations, particular attention was paid to the optimal orientation the workpiece in working charge. The results of the research presented in this article confirm the benefit of horizontal orientation of the workpiece to the motion of the media in the working charge.

Keywords: disc centrifugal machine, geometrical structure

1. INTRODUCTION

During processing in disc centrifugal machine, the workpieces are placed loosely in rotating processing media. Their temporary position in relation to the processing media is random, which indeed enables surface treatment, but this process is not optimal. There is a relatively high percentage of the media sliding, rolling and scratching the surface with a relatively small percentage of micro-cutting. The energy of the processing charge is used to a limited extent to remove surface irregularities formed in the previous operations. This is due to the different speeds of the individual abrasive media in the rotating processing charge and their loose interaction with the surface of the workpieces. The structure of the rotating processing charge is characterized by toroidal movement, which is variable in terms of speed and energy, resulting from the fact that media are firstly lifted towards wall of the processing bowl and subsequently they fall down after speed loss due to frictional resistance.

Moreover, as the research carried out at the Department of Production Engineering has shown, there is a differentiation of the energy distribution of the working charge in its shaped spatial structure at a given rotational speed [1, 2] (Fig. 2). As a result the surface

treatment is characterised by a large variety of media interaction modes and a large energy diversification

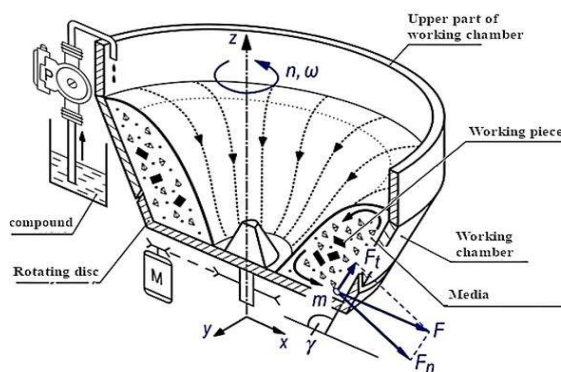

Fig. 1. The paths of movement of the abrasive media in the working container of the disc centrifugal machine [1, 2]

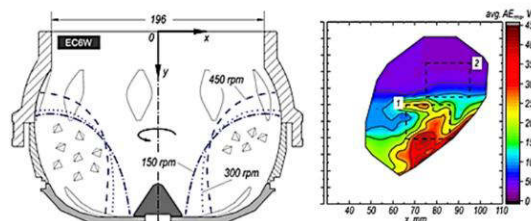

Fig. 2. The paths of movement of the abrasive media in the working container of the disc centrifugal machine [1, 2]

Considering the above, the finishing process should be improved in order to use the energy of the processing charge in a more efficient way. One of such methods is specific orientation of the workpiece in a working holder, what allows to accumulate the abrasive media energy on a given surface of the workpiece and in result leads to increased process efficiency. It may be particularly advantageous if the workpiece is located in the area of the highest energy level [3,4].

Works in this scope are carried out at the Department of Production Engineering of the Koszalin University of Technology, taking into account the workpiece holder with 4 degrees of freedom, ensuring a specific orientation of the workpiece in the working charge. Their essence is to determine the optimal processing position in relation to the finishing efficiency and the quality of the finished surfaces.

2. METHODOLOGY OF EXPERIMENTAL RESEARCH

The aim of the research was to determine how the orientation of the workpiece in the working charge influences the efficiency of surface finishing and the geometric structure quality of its surface.

The tests were carried out in disc centrifugal machine EC6 manufactured by Zakład Mechaniki Maszyn AVALON Polska (Fig. 3).

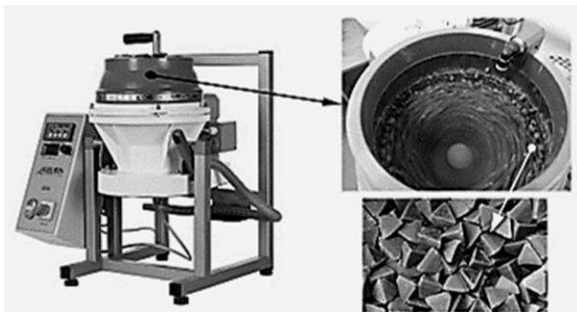

Fig. 3. EC6 rotary container smoothing machine

The workpiece orientation in the working charge was carried out by use of a holder with 4 degrees of freedom, in the area of the highest kinetic energy potential for a given rotational disc speed of the disc centrifugal machine. This holder allows the angular rotation of the workpiece in relation to the direction of the processing media rotary movement in the vertical orientation (α) and its angular inclination in the horizontal orientation (β). It is also possible to combine these two orientations (α/β) – Fig. 4.

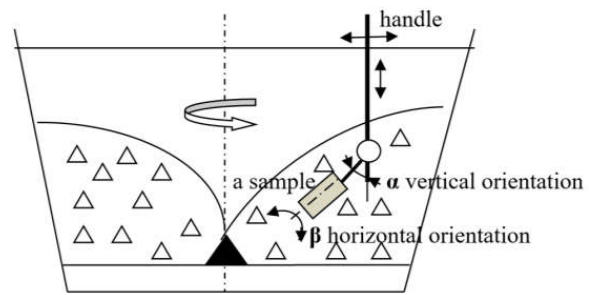

Fig. 4. Possibilities of workpiece orientation in the working zone of the disc centrifugal machine

Such design of the holder enables the workpiece to be moved in the axial section of the working charge, allowing it to be placed in the area of the highest working charge energy and providing 2-axis angular orientation (Fig. 5).

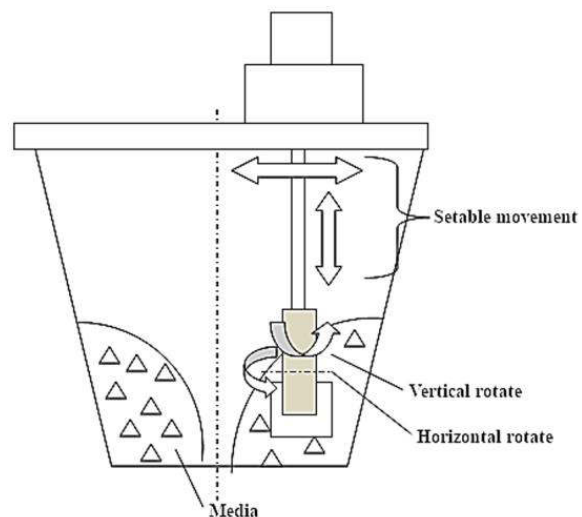

Fig. 5. Orientation of samples in the working charge: a) vertical, b) horizontal

The obtained results were related to finishing of the workpiece without orientation, placed loosely in a rotating working charge.

The tested workpieces were flat-parallel shaped with dimensions of 20×30×2 mm, made from PA11 aluminum alloy. The resin chips 02PP15 (nomenclature by AVALON) were used as the working charge. The treatment was carried out at the disc speed of 300 rpm. Duration of the finishing process was 15 minutes. The use of samples with relatively low hardness facilitated the mapping and traces observation of the impact of abrasive blocks on the treated surface. The research program is presented in Fig. 6.

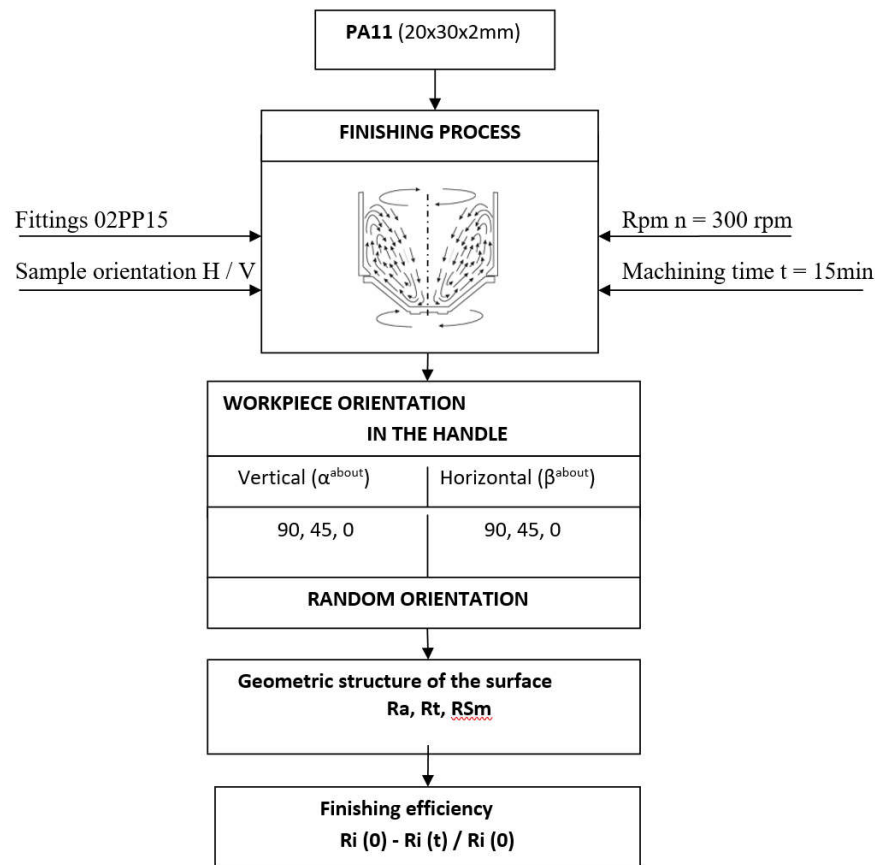

Fig. 6. Diagram of the research program

The results of the conducted tests confirm that in relation to the tested PA11 alloy workpieces, the intensity of the finishing and in result the geometric structure of the treated surface depend significantly on the vertical orientation of the object in relation to the direction of the work charge movement. This applies as well to the position of an object in a vertical, horizontal, angular and torsional position.

In case of perpendicular positioning of the workpiece in relation to the direction of the media movement, there is visible a relatively greater energy of their impact on the treated surface than in case of the horizontal positioning. This results in higher efficiency of finishing. The surface structure of the workpiece is also different, it is characterized by a greater degree of development, which is the result of increased number of finishing traces in form of craters and recessed areas. In case of angular orientation of the workpiece the processing intensity is lower, however higher than in case of horizontal orientation. In these two cases, the geometric structure of the treated surface is significantly smoothed (Fig. 7).

Whereas the angular orientation 45° in relation to its own axis, in each of these three cases, does not make significant difference both in terms of the finishing intensity and of the geometric structure shaping of the treated surface

In quantitative terms, the influence of all tested workpiece orientations on elementary mechanisms and the smoothing efficiency is presented in Table 1-3. It covers three basic cases (Fig. 8):

- perpendicular orientation of the tested surface in relation to the media movement direction a),
- parallel orientation of the tested surface in relation to the direction of media movement direction b),
- torsional orientation of the tested surface in relation to the direction of media movement direction c).

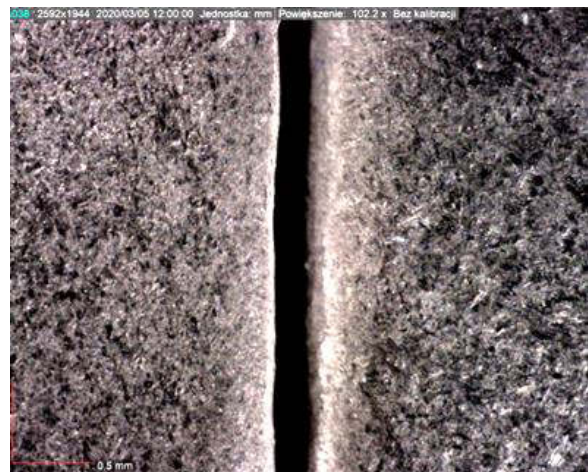

Fig. 7. Edge rounding of samples made from PA11 aluminium alloy after 15 min of smoothing:

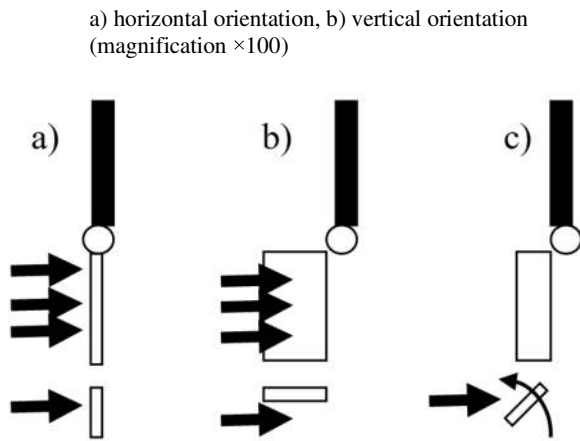

Fig. 8. Types of workpiece surface orientation in a vertical arrangement

Based on these analyzes, it can be concluded that the use of a different orientation of the workpiece during finishing the disc centrifugal machine has a significant impact on the mechanisms of shaping the geometric structure of the treated surface. This is due to the impact direction of abrasive media on it and the associated participation of individual elementary features occurring in this process.

And so, in the case of operating the abrasive media in the direction perpendicular to the surface, the main shaping mechanism are local craters, which result from media impact points. The structure of such surfaces is characterized by high isotropy, but also by relatively highest level of roughness. On the other hand, in case

of media movement in the direction parallel to the finished surface, directed processing traces begin to dominate, resulting from micro-cutting and grooving, which ensures the lowest surface roughness for all tested angular orientations in the horizontal system. There is a visible orientation of the surface, it is not fully stochastic and is locally differentiated. On the other hand, the SGP shaping mechanism in a mixed system is more complex, in which the object takes the same positions as in the two previous systems and is additionally rotated by an angle of 45°. In this case the advantage is the favorable accumulation of the media's toroidal motion and the rotational motion. On the other hand, in case of an inclined workpiece orientation, along with the increase of the inclination angle, the surface roughness decreases with the lowest intensity.

These features are additionally overlapped by the toroidal movement of the fittings in the working charge (Fig. 1), which affects the directions of media movement in local areas. However, the primary influence on the SGP shaping is the rotational movement of the media, which is characterized by a much higher kinetic energy.

What is even more interesting, for all tested horizontal and angle orientations in relation to its axis, the lowest values of roughness parameters occur for workpiece in the horizontal orientation (Fig. 9). This is probably the result of the beneficial effect, which base on the synergy of the rotary motion and the internal toroidal motion of the working charge.

Tab. 1. The dominant process features occurring when finishing the workpiece in the holder with an angular orientation perpendicular to the direction of the media movement (a)

	$Ra = 1.15 \mu\text{m}$ $Rt = 10.8 \mu\text{m}$ $RSm = 0.159 \text{ mm}$	<p>A large number of craters (depressions) of significant surface density and varied depth. Relatively few scratches resulting from the micro-cutting process. Surface structure with a high degree of isotropy. Relatively high surface roughness.</p>
	$Ra = 0.76 \mu\text{m}$ $Rt = 10.95 \mu\text{m}$ $RSm = 0.121 \text{ mm}$	<p>Decreasing number of craters, increasing number of micro-nicks and scratches. Progressive smoothing of the surface. The degree of surface anisotropy increases. Lowering the surface roughness.</p>
	$Ra = 0.54 \mu\text{m}$ $Rt = 7.57 \mu\text{m}$ $RSm = 0.097 \text{ mm}$	<p>A large number of scratches resulting from micro-cuts and many marks resulting from grooving, rubbing and rolling on fittings. Increase in the degree of anisotropy of the surface. Significant smoothing and a decrease in roughness.</p>

Tab. 2. Dominant process features occurring when finishing the workpiece in the holder with an angular orientation parallel to the direction of the media movement (b)

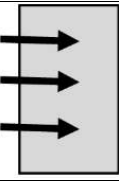
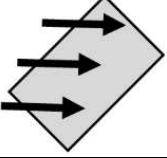
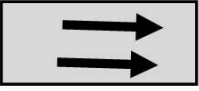
	$Ra = 1.12 \mu\text{m}$ $Rt = 10.76 \mu\text{m}$ $RSm = 0.145 \text{ mm}$	A large number of scratches and traces of micro-cuts with significant surface compaction and varied depth. Relatively few craters and depressions. Surface structure with a high degree of anisotropy. Relatively high surface roughness.
	$Ra = 0.55 \mu\text{m}$ $Rt = 7.12 \mu\text{m}$ $RSm = 0.098 \text{ mm}$	Decreasing number of craters, increasing number of micro-nicks and scratches. Significant surface smoothing. Increase in the degree of anisotropy of the surface. Light structure orientation.
	$Ra = 0.53 \mu\text{m}$ $Rt = 5.97 \mu\text{m}$ $RSm = 0.097 \text{ mm}$	Decreasing number of craters, increasing number of micro-nicks and scratches. Progressive further smoothing of the surface. Increase in the degree of anisotropy of the surface. Express the orientation of the structure.

Tab. 3. The dominant process features occurring during finishing of the workpiece in the holder with a torsional orientation in relation to the direction of media movement (c)

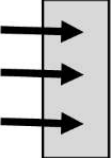
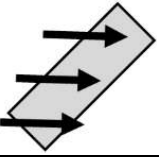
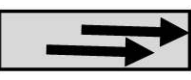
	$Ra = 0.98 \mu\text{m}$ $Rt = 10.10 \mu\text{m}$ $RSm = 0.116 \text{ mm}$	A relatively large number of craters and depressions with significant surface density and varying depths. A relatively small number of scratches resulting from the finishing process. Surface structure with a high degree of isotropy. High surface roughness.
	$Ra = 0.95 \mu\text{m}$ $Rt = 10.41 \mu\text{m}$ $RSm = 0.121 \text{ mm}$	Decreasing number of craters, increasing number of micro-cuts and scratches. Progressive smoothing of the surface. The degree of surface anisotropy increases and the roughness of the surface is minimally lowered.
	$Ra = 0.53 \mu\text{m}$ $Rt = 0.087 \mu\text{m}$ $RSm = 0.097 \text{ mm}$	A large number of scratches resulting from micro-cuts and many marks resulting from media friction and grinding. Increase of the anisotropy degree and orientation of the structure. Surface smoothed.

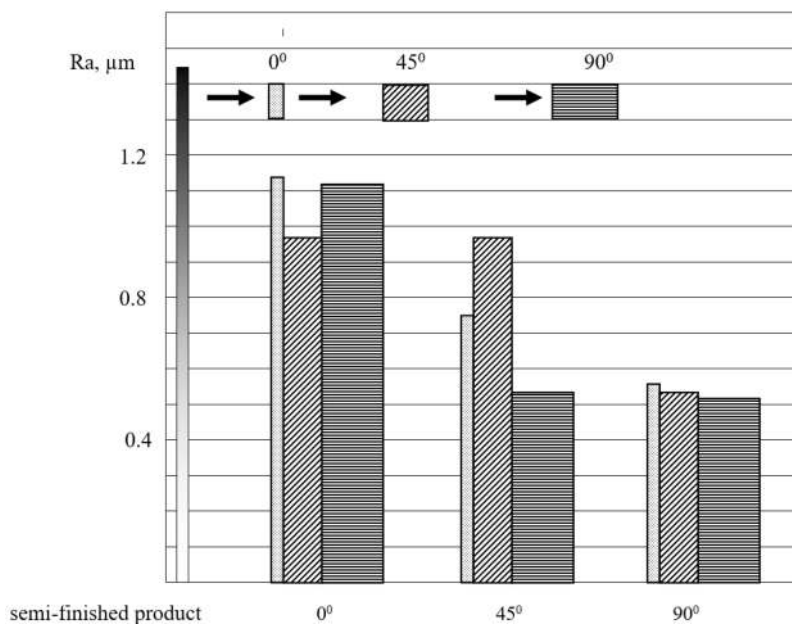

Fig. 9. The influence of the sample inclination angle in the horizontal system and the angle of its rotation in relation to the axis on the shaping of the Ra roughness parameter in the smoothing process