

BUBBLE BOILING IN FLOW OF REFRIGERATING MEDIA

Tadeusz BOHDAL^{1*}

^{1*} Faculty of Mechanical Engineering, Department of Power Engineering, Koszalin University of Technology, Raclawicka 15-17, 75-620, Koszalin, Poland, e-mail: krzysztof.nadolny@tu.koszalin.pl

(Received 3 March 2017, Accepted 26 May 2017)

Abstract: The paper describes results of investigations of heat transfer and pressure drop during bubbly boiling of refrigerating media. In this article were presented of authors own experimental studies and were proposed new simple calculation model describing bubble boiling in the tubular channel. The author attempts to put forward a simplified description of the process of bubble boiling in a straight pipe. The two-phase one-component (liquid-vapour) system is treated as a continuum governed by the laws of conservation of energy, momentum and mass. The continuum is characterised by parameters that describe the two-phase system, such as density of the two-phase mixture, static void fraction or static equilibrium dryness fraction. In view of engineering applications, a one-dimensional model is used where physical quantities are cross-section averaged. This way the average velocity, pressure, temperature, and so on, are introduced. The results of the proposed model have been compared with the results of the experimental research with satisfactory compliance.

Keywords: bubbly boiling, heat transfer and pressure drop, tubular channel

1. INTRODUCTION

Bubble boiling is a process of frequent occurrence in channel flows of numerous engineering applications, only to mention steam generators, steam boilers, nuclear reactors, evaporators in refrigeration units. Theoretical and experimental investigations to better our recognition of this process have been carried out for years and are still in progress. These investigations brought a number of experiment-based correlations to describe the heat transfer and flow resistance during bubble boiling of media such as water, ammonia and freons used so far. However, more fundamental and applied research works are in demand. Particularly necessary are investigations concerning new media recently introduced, for example new environment-friendly refrigerants [2, 10]. For several decades, some theoretical models have been elaborated where the investigators make attempts to describe two-phase flows of boiling media [3, 4, 5, 7, 11, 12]. The richly commented review of theoretical models published across the literature can be found in works [1, 8, 6, 9].

2. EXPERIMENTAL INVESTIGATIONS

Fundamental experimental investigations were carried out at a specially designed test facility erected at the Department of Power Engineering of the Technical University of Koszalin. The test facility consists of the following main elements:

- investigation system, comprising test sections and instrumentation,
- supply system to feed the installation with the refrigerant,
- electrical installation,
- installation for cooling water,
- measuring and control apparatus with computer recording and processing of data.

A schematic of the test facility is presented in Fig. 1.

There are two test sections with instrumentation. The test sections are made in the form of one vertical and one horizontal straight channel - pipe stretches of length 0.66 m each, with a circular cross-section of inner diameter 13 mm. Pipes are made of copper with the wall thickness equal to 1.5 mm. The measuring sections are electrically heated. The inlet and outlet of the experimental channel are made transparent in the form of glass pipes of length 0.25 m and inner

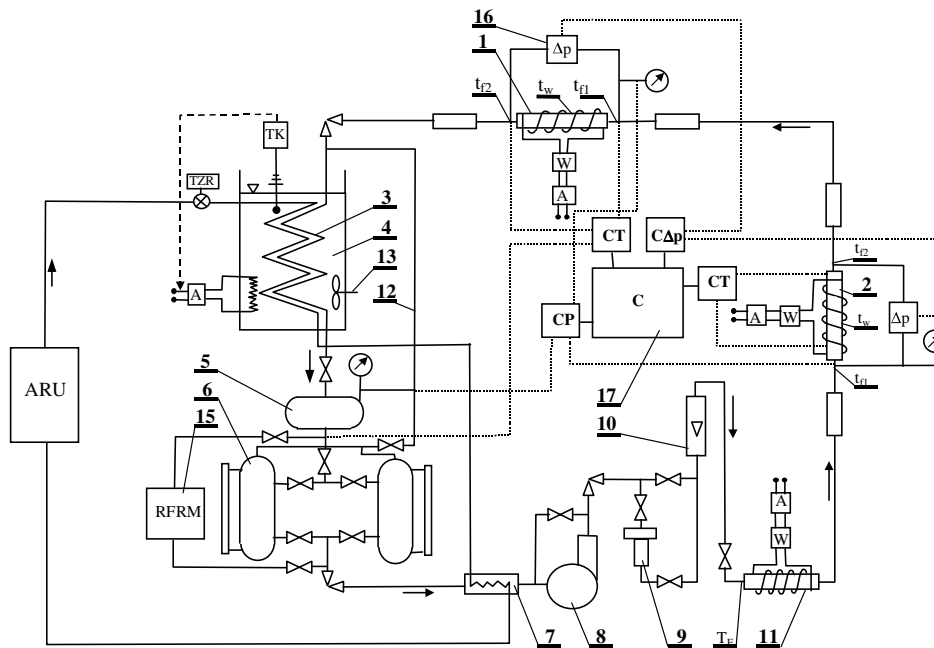

Fig. 1. SEM A schematic of the test facility; 1- horizontal test section with instrumentation, 2 vertical test section with instrumentation, 3- condenser, 4- coolant vessel, 5- refrigerant vessel, 6- measuring vessel, 7- subcooler, 8- pump, 9- filter, 10- rotameter, 11- preheater, 12- pressure equalising pipe, 13- stirrer, 14- heating element, 15- electronic flow meter of Sonoflo type, 16- electronic pressure difference transducer, 17- computer connected with transducers for measurements of temperature, pressure and pressure difference, ARU- auxiliary refrigeration unit, W- watt meter, A- autotransformer, RFRM- refrigerant flow rate meter, Δp - pressure difference transducer, CP- pressure transducer interface, C Δp - pressure difference transducer interface, CT- temperature transducer interface, C- computer with accessories

diameter 13 mm to enable observations of the structure of the flowing two-phase mixture.

The feed station is equipped with the following elements: refrigerant condenser 3, coolant vessel 4, refrigerant vessel 5, measuring vessels 6, subcooler 7, pump 8, filter 9, rotameter 10, refrigerant preheater 11. The flow of the refrigerant in the cycle is driven by a gear pump. The maximum volumetric flow rate of the refrigerant is equal to 440 l/h (122 10⁻³ m³/h). The mass flux of the refrigerant flowing through the measuring sections is controlled by throttling at the delivery side of the pump and partly by extraction of the refrigerant onto the suction side of the pump.

The circulating pump sucks the refrigerant, subcooled by a few Kelvin, from the measuring vessels to which the refrigerant flows gravitationally down from the condenser through a pressure vessel (auxiliary pipes 12 are used to equalise the pressure in the system of gravitational flow of the refrigerant). The condenser is made in the form of tube coils submerged in a vessel filled with the solution of ethylene glycol. The heat is absorbed by a compressor refrigeration system whose coil evaporator is placed in the same vessel where the coils of the condenser are submerged. The installation of the compressor refrigeration system consists of: a compressor-condensing aggregate with water cooling, condenser, thermostatic

expansion valve, liquid subcooler, elements of refrigeration automatics. The coolant vessel is equipped with a stirrer 13 and heating elements 14 to assure the required temperature of the coolant. The change of heating power of the elements 14 is achieved by means of an autotransformer and contact thermometer. The possibility of control of the coolant temperature in the vessel of the condenser enables the stabilisation of the condensation temperature of the refrigerant as well as keeping the pressure in the condenser and in the test section constant. In order to cool the refrigerant a subcooler 7 is used. The preheater 11 serves to achieve the required temperature of the refrigerant at the inlet to the test section. The refrigerant passes through a filter and humidity absorber 9. An electronic flow meter Sonoflo 15 (manufactured by Danfoss) calibrated in preliminary measurements is applied to measure the flow rate of the refrigerant. The flow rate of the medium can also be measured by means of the calibrated measuring vessels 16. The rotameter 10 plays a role of indicator of flow stabilisation. Pressure and pressure difference measurements at characteristic stations of the test sections are made by means of tensometric sensors. The wall temperature at the heated stretch of the flow channel as well as the temperature of the medium are measured with the aid of copper-constantan thermoelements, with thermoelectrodes

of diameter 0,35 mm and length 2 m. Thermoelectric sensors for temperature measurements of the medium are submerged in the liquid spanning on 0.7 of the channel inner diameter. Weld joints of the thermoelements for wall temperature measurements are mounted at a depth of 0.5 mm from the outer surface of the channel. All quantities obtained from the sensors of temperature, flow rate and pressure are converted into voltage signals and fed into the computer. The software enables recording and processing of the acquired data. The system of computer aided experimental investigations facilitates planning of measurements, their control and processing of the obtained results. Experimental investigations are carried out for refrigerating media having a certificate of liquid purity from the manufacturer. A filter 9 is installed upstream of the test sections so as to remove possible foreign bodies and humidity from the refrigerant. The experiments are conducted under constant thermal and flow parameters of the medium at the inlet to the test sections. Following refrigerating media: R134a, R404A and R507 are investigated. The sample results of measurements of the heat transfer coefficient and pressure drop are presented in Figs. 2-5.

Local values of the heat transfer coefficient α and pressure drop Δp are charged with some systematic and random errors. Due to a relatively small number of measurements performed at the same conditions, random errors will not be estimated here. However, the systematic error following from the measuring and computational method can be evaluated as they do not depend on the number of measurements. The mean-square error has been estimated. In the case under consideration, the mean-square errors for the heat transfer coefficient α and pressure drop Δp , determined based on the measurements, depend mainly on the mass flux density ($w\rho$) and heat flux density q . Bearing in mind the above, the estimation of the mean-square error has been carried out in four variants, taking into account the maximum and minimum values of the mass flux density ($w\rho$) and heat flux density q . It has been found from the calculations that the experimental data are charged with the mean-square error of 9-10 %.

3. COMPUTATIONEL MODEL

Foundations of the model:

1. A two-phase one-component mixture under saturation temperature T_s flows down a straight pipe inclined at a certain angle β to the horizontal plane.
2. The flow is turbulent. The mass flux density is equal to ($w\rho$).
3. The mixture is characterized by the dryness fraction x and void fraction φ .

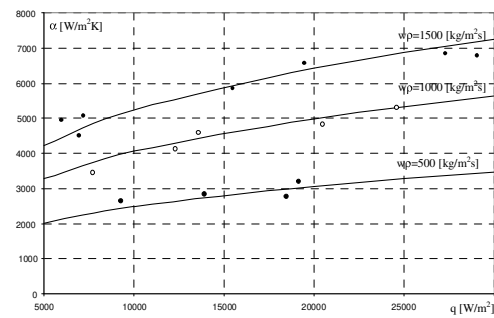

Fig. 2. The results of measurements of heat transfer coefficient in the form $\alpha = f(q)$ for $(w\rho) = \text{const}$; $T_s = -20^\circ\text{C}$, $x = 0.05$, vertical channel, R507

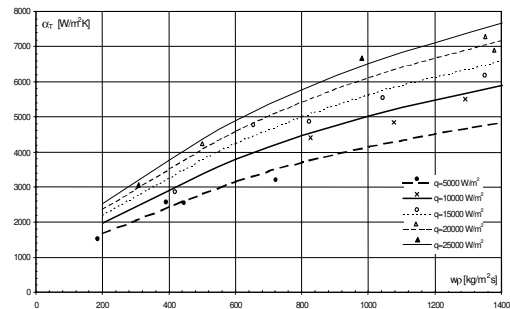

Fig. 3. The results of measurements of heat transfer coefficient in the form $\alpha = f(w\rho)$ for $q = \text{const}$; $T_s = -10^\circ\text{C}$, $x = 0.1$, horizontal channel, R404A

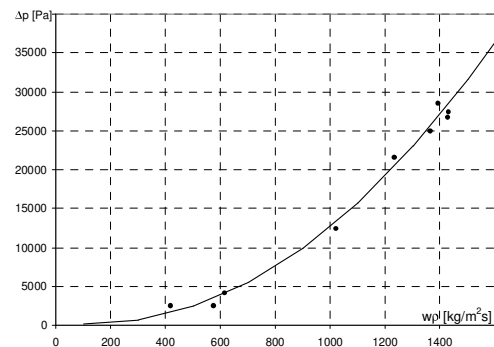

Fig. 4. The results of measurements flow resistance in the form $\Delta p = f(w\rho)$ for $q = 15\text{kW/m}^2$, $T_s = -20^\circ\text{C}$, $x = 0.1$, horizontal channel, R507

4. Heat is supplied to the channel from the surroundings. The heat flux density is constant along the pipe and equal to q_w .
5. The process of boiling with generation of vapour bubble takes place in the channel.
6. The process takes place under steady-state conditions.

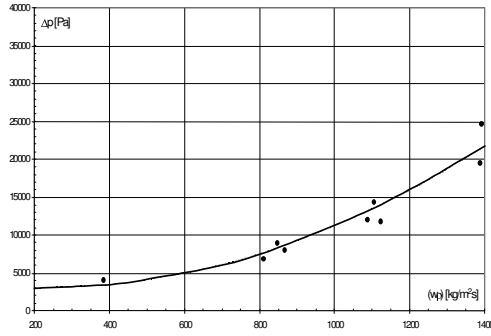

Fig. 5. The results of measurements flow resistance in the form $\Delta p = f(w\rho)$; $q = 20 \text{ kW/m}^2$, $T_s = 0^\circ\text{C}$, $x = 0.1$, vertical channel, R404A

As declared in the introduction, the conservation equations to describe the boiling process in channel flow will be written in a simplified engineering-oriented one-dimensional representation:

- energy conservation equation:

$$\rho \frac{\partial h}{\partial t} - \frac{\partial \dot{p}}{\partial t} + \rho w \frac{\partial h}{\partial z} - w \frac{\partial \dot{p}}{\partial z} = \frac{\tau_w C}{A} + \frac{q_w C}{A}, \quad (1)$$

- momentum conservation equation:

$$\rho \frac{\partial w}{\partial t} + \rho w \frac{\partial w}{\partial z} = \rho g \cos \beta - \frac{\tau_w C}{A} - \frac{\partial \dot{p}}{\partial z}, \quad (2)$$

- mass conservation equation:

$$\frac{\partial \rho}{\partial t} + w \frac{\partial \rho}{\partial z} + \rho \frac{\partial w}{\partial z} = -\rho w \frac{1}{A} \frac{\partial A}{\partial z}. \quad (3)$$

After introduction of the state equation in the form:

$$\rho = \rho(h, p), \quad (4)$$

and subsequent transformation, the set of Eqs. (1-3) can be rewritten as follows:

$$\rho \frac{\partial h}{\partial t} - \frac{\partial \dot{p}}{\partial t} + \rho w \frac{\partial h}{\partial z} - w \frac{\partial \dot{p}}{\partial z} = \frac{\tau_w C}{A} + \frac{q_w C}{A}, \quad (5)$$

$$\rho \frac{\partial w}{\partial t} + \rho w \frac{\partial w}{\partial z} + \frac{\partial \dot{p}}{\partial z} = \rho g \cos \beta - \frac{\tau_w C}{A}, \quad (6)$$

$$D_1 \frac{\partial \dot{p}}{\partial t} + D_2 \frac{\partial h}{\partial t} + w D_1 \frac{\partial \dot{p}}{\partial z} + w D_2 \frac{\partial h}{\partial z} + \rho \frac{\partial w}{\partial z} = -\rho w \frac{1}{A} \frac{\partial A}{\partial z}, \quad (7)$$

where:

$$D_1 = \left(\frac{\partial \rho}{\partial \dot{p}} \right)_h, \quad D_2 = \left(\frac{\partial \rho}{\partial h} \right)_p. \quad (8)$$

For steady-state conditions, the mass conservation equation (7) can be expressed in an integral form:

$$w\rho A = \dot{m} = \text{const}. \quad (9)$$

Placing Eq. (9) into Eqs. (5 - 6) gives:

$$-\frac{d\dot{p}}{dz} + \rho \frac{dh}{dz} = \frac{\tau_w C}{A} + \frac{q_w \rho C}{\dot{m}}, \quad (10)$$

$$\left(1 - \frac{\dot{m}^2 D_1}{A^2 \rho^2} \right) \frac{d\dot{p}}{dz} - \frac{\dot{m}^2 D_2}{A^2 \rho^2} \frac{dh}{dz} = \frac{\dot{m}^2}{A^3 \rho} \frac{dA}{dz} + g \rho \cos \beta - \frac{\tau_w C}{A}. \quad (11)$$

Eqs. (10-11) make up a set of ordinary differential equations that incorporate the laws of conservation of energy, mass and momentum, as well as the state equation $\rho = \rho(h, p)$. The closure equations describing the heat flux density q_w and shear stress τ_w at the inner wall of the channel are as follows:

$$\tau_w = \frac{1}{2} f \frac{\dot{m}^2 (1-x)^2}{\rho A^2 (1-\phi)^2}, \quad (12)$$

where:

$$A = \frac{\pi \cdot D^2}{4}, \quad f = 0,316 \cdot Re^{-0,25}, \quad Re = \frac{\dot{m} \cdot D \cdot (1-x)}{\rho \cdot A \cdot v \cdot (1-\phi)}. \quad (13)$$

Parameters that characterize the two-phase mixture are determined from the following relationships

- equilibrium dryness fraction x_R :

$$x_R = \frac{h - h'}{h'' - h'}, \quad (14)$$

- void fraction ϕ :

$$\phi = x_R \frac{\rho}{\rho''}, \quad (15)$$

- where ρ is the density of the two-phase mixture:

$$\rho = \frac{\rho' \cdot \rho''}{\rho'' + x_R (\rho' - \rho'')}. \quad (16)$$

The heat transfer at the inner wall of the channel can be described by the *Newton* law:

$$q_w = \alpha \cdot (T_w - T_f), \quad (17)$$

where the fluid temperature T_f is equal to the saturation temperature T_s due to the saturation pressure. Given the heat transfer coefficient α , one can find the temperature at the inner wall of the heated channel:

$$T_w = T_s + \frac{q_w}{\alpha}. \quad (18)$$

The dependence determined by the R134a, R404A and R507 refrigerant was used to determine the magnitude of the heat transfer coefficient α :

$$Nu = A \cdot (Re)^{n_1} \cdot (Fr)^{n_2} \cdot (Ku)^{n_3} \cdot (Bo)^{n_4}, \quad (19)$$

where: $A = 4,5 \cdot 10^{-5}$ (vertical channel), $A = 5,1 \cdot 10^{-5}$ (horizontal channel), $n_1 = 2.42$; $n_2 = -0.35$; $n_3 = 1.30$; $n_4 = -1,08$,

The following quantities have to be assumed to get started with the calculations:

- geometrical dimensions of the channel,
- heat flux density at the inner wall,
- mass flux density of the boiling medium,
- a correlation that enables the determination of the heat transfer coefficient α ,
- boundary conditions at the inlet section of the channel, that is the inlet specific enthalpy $h = h_1$ and pressure $p = p_1$ of the two-phase mixture.

4. RESULTS OF CALCULATIONS

The numerical calculations were carried out based on the above described computational model of bubble boiling. As a result of calculations, a number of parameters that characterize the process of bubble boiling in channel flow were evaluated, including the heat transfer coefficients and pressure drops. The variation of flow parameters along the channel where the process of bubble boiling takes place is presented in Fig. 6 and 7 for refrigerants R134a and R404A.

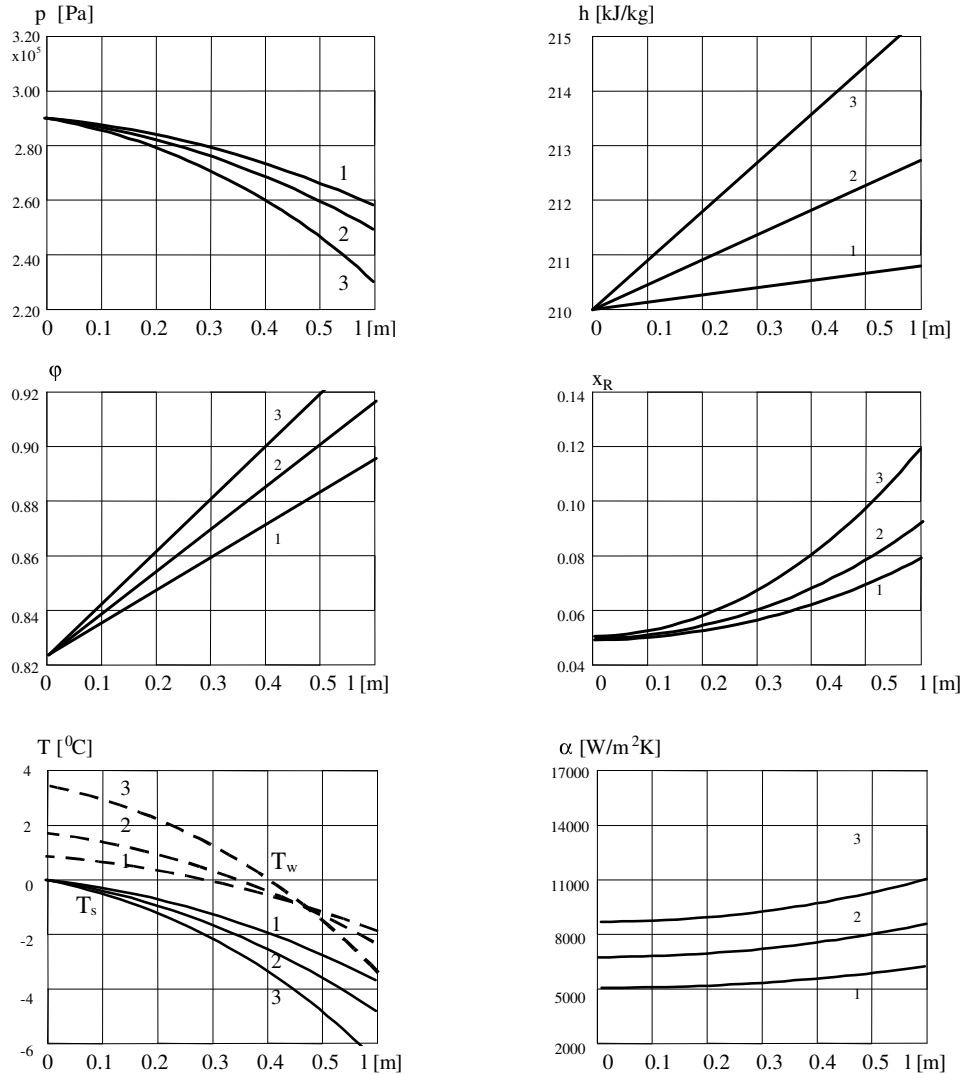

Fig. 6. The distribution of quantities describing the process of bubble boiling of refrigerant R134a as a function of axial coordinate of the horizontal channel: $T_s = 0^{\circ}\text{C}$, $p_1 = 0.293$ MPa, $h_1 = 210$ kJ/kg, $(w_p) = 1000$ kg/m²s, 1 - $q_1 = 5000$ W/m², 2 - $q_2 = 15000$ W/m², 3 - $q_3 = 30000$ W/m²

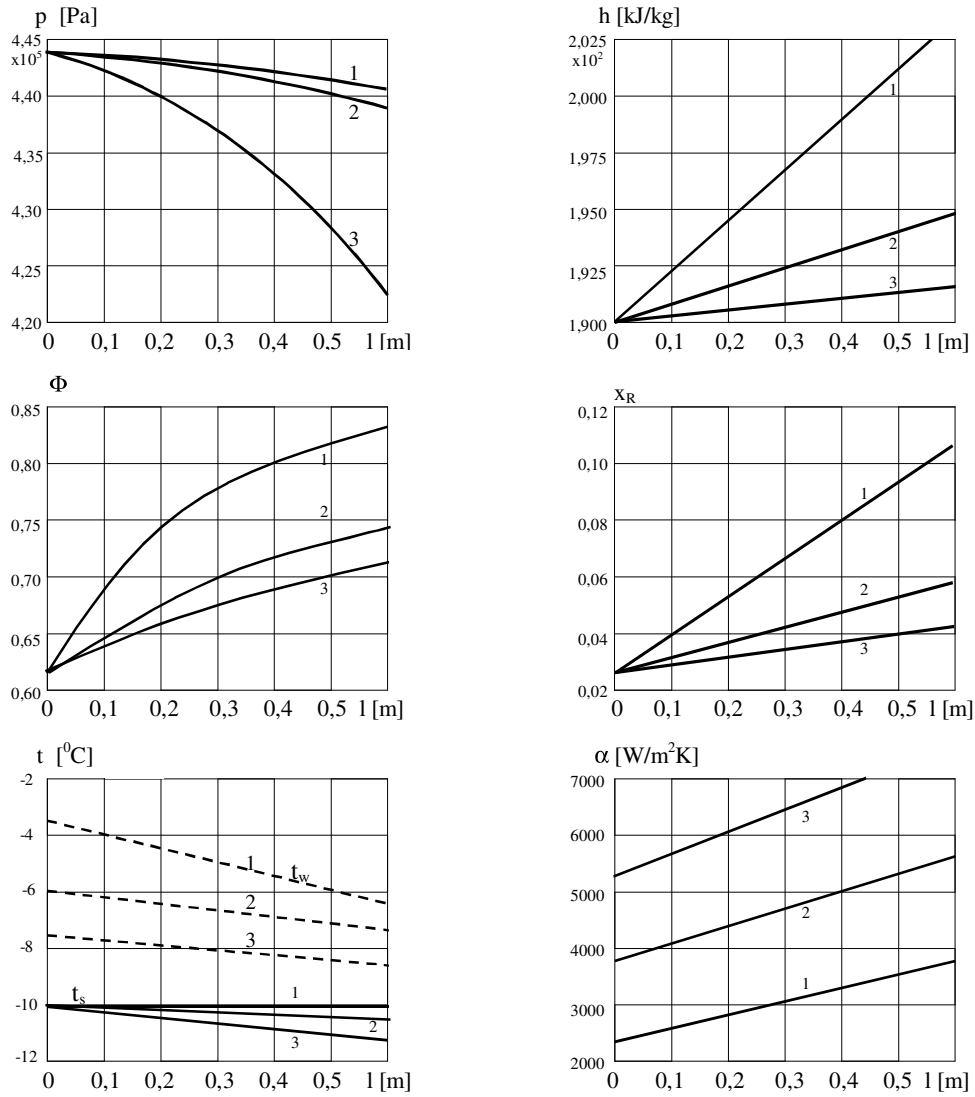

Fig. 7. The distribution of quantities describing the process of bubble boiling of refrigerant RR404A as a function of axial coordinate of the horizontal channel: $q = 15\,000\text{ W/m}^2$, $T_{oi} = -10\text{ }^\circ\text{C}$, $p_i = 0,444\text{ MPa}$, $h_i = 190\text{ kJ/kg}$, $w\rho_i = 200\text{ kg/m}^2\text{s}$, $w\rho_2 = 600\text{ kg/m}^2\text{s}$, $w\rho_3 = 1600\text{ kg/m}^2\text{s}$

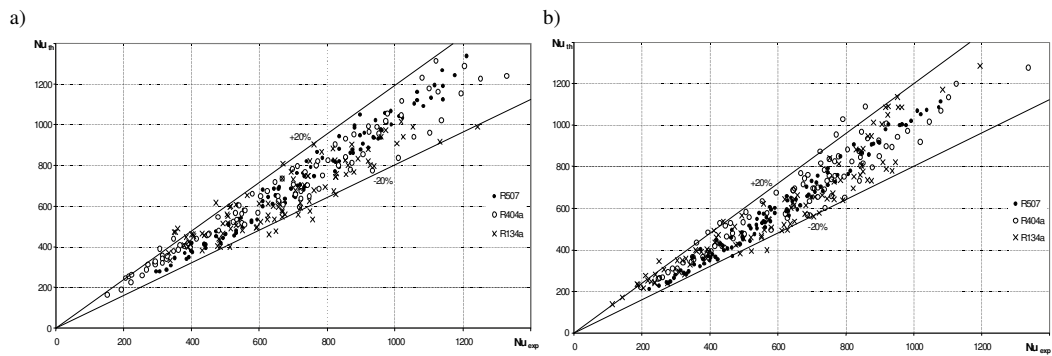

Fig. 8. The comparison of Nusselt number calculated from the presented model Nu_{th} and determined from own experimental investigations Nu_{exp} : a) horizontal channel, b) vertical channel

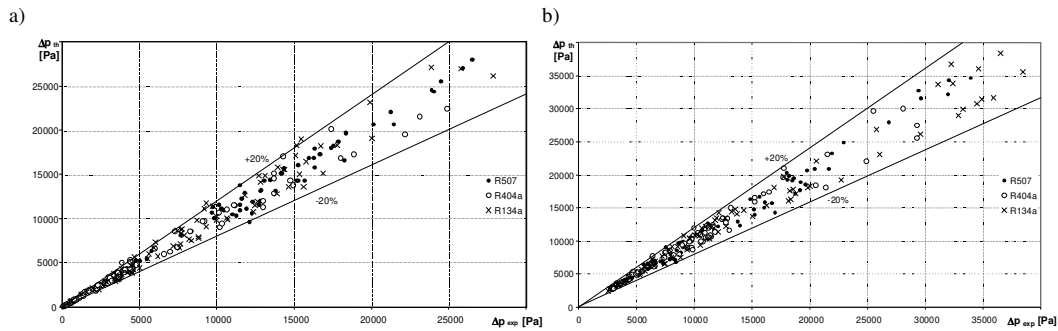

Fig. 9. The comparison of flow resistance in the pipe channel obtained from theoretical calculations Δp_{th} and own experimental investigations Δp_{exp} : a) horizontal channel, b) vertical channel

The calculations were performed in a number of series. For each series, the parameters of the refrigerating medium at the inlet to the channel were assumed constant, changing only one quantity at a time, for example the heat flux density at the channel wall q_w or the mass flux density of the flowing medium ($w\rho$).

The presented graphs are profiles of the following physical quantities: pressure, enthalpy, void fraction, dryness fraction, temperature and heat transfer coefficient α . The pressure drop Δp along the channel is accompanied by the increase of the enthalpy h , void fraction φ and dryness fraction x_R . This stimulates intensification of heat transfer which is pronounced by a decrease in the temperature of the heated wall T_w and increase of the heat transfer coefficient α .

The comparison of computational results based on the presented model and experimental data [2], [3] is shown in Figs. 8 and 9. The obtained results concern heat transfer expressed in terms of the Nusselt number Nu and pressure drops in the pipe channel of inner diameter $D = 13$ mm and length $L = 0,6$ m. The calculations and experiments were carried out for refrigerants R134a, R404a and R507. It was found from the comparison that the discrepancy between the computational results and experimental data does not exceed $\pm 20\%$ for 95 % of the collected results concerning heat transfer and all results referring to flow resistance.

4. CONCLUSIONS

The presented theoretical model that draws on conservation equations for energy, momentum and mass of a one-dimensional continuum, although containing a number of simplifications, is capable of accurately describing the process of bubble boiling of refrigerating media in channel flows. Numerical calculations performed with the aid of an experiment-based correlation (19) enable us to obtain the continuous distribution, along the channel, of quantities that characterise the process of bubble boiling. The comparison of computational results and experimental data, own and from other authors, speaks in favour of the proposed method of determination of heat transfer coeffi-

icients α and pressure drops. The method can be applied to several refrigerating media in a wide range of heat and flow parameters, assuring a decent accuracy to $\pm 20\%$, and therefore can be serviceable in design of heat exchangers for refrigeration units as well as complete refrigeration units.

Nomenclature

Symbols

| | |
|-----------|--|
| A | – cross-sectional area of the channel, m^2 |
| C | – flooding circumference, m |
| D | – channel diameter, m |
| f | – flow number, |
| g | – acceleration of gravity, m/s^2 |
| h | – specific enthalpy, kJ/kg |
| L | – channel length, m |
| \dot{m} | – mass flow rate, kg/s |
| p | – pressure, MPa |
| q | – heat flux density, W/m^2 |
| Re | – Reynolds number, |
| t | – time, s |
| T | – temperature, $^\circ C$ |
| x | – dryness fraction, |
| $w\rho$ | – mass flux density, kg/m^2s |
| w | – velocity, m/s |
| z | – axial coordinate of the channel, |

Greek symbols

| | |
|-----------|--|
| α | – heat transfer coefficient, W/m^2K |
| β | – pipe slope with respect to the horizontal plane, |
| φ | – static void fraction, |
| ρ | – density, kg/m^3 |
| τ | – time, s |

Subscripts

| | |
|-------|----------------------|
| exp | – experimental, |
| f | – fluid, |
| h | – constant enthalpy, |
| p | – constant pressure, |
| R | – equilibrium, |
| s | – saturation, |
| th | – theoretical, |
| w | – wall, |
| 1 | – inlet, |
| 2 | – outlet, |

Subscripts

prim – liquid,
bis – vapour,

References

1. Bilicki Z.: Analysis of simplifications in one-dimensional equations for two-phase channel flows. *Transactions of the Institute of Fluid-Flow Machinery, Gdansk* 1983, no 168/1067.
2. Bohdal T.: Investigations of environmentally friendly refrigerants phase changes in minichannels. *Annual Set of The Environment Protection*, Vol. 15, 107 – 126, 2013.
3. Cheng K.H., Aradi M.M., Dessiatoun S.: Compo- and enhancement of boiling heat transfer of R134a in a tube bundle. *ASHRAE Transaction* 1995, Vol. 101, Part I.
4. Eckeis S.J., Doerr T.M., Pate M.B.: Zu-tube heat transfer and pressure drop of R134a and microfin tube. Part I. Evaporation, *ASHRAE Transactions*, Vol. 100, Part I, 1994.
5. Jung S., Kim H.: An experimental method to simultaneously measure the dynamics and heat transfer associated with a single bubble during nucleate boiling on a horizontal surface, *International Journal of Heat and Mass Transfer* 73 (2014) 365–375.
6. Kharangate C.R., Mudawar I.: Review of computational studies on boiling and condensation, *International Journal of Heat and Mass Transfer* 108 (2017) 1164–1196.
7. Kharangate C.R., Lee H., Mudawar I.: Computational modeling of turbulent evaporating falling films, *International Journal of Heat Mass Transfer* 81 (2015) 52–62.
8. Kim J.: Review of nucleate pool boiling bubble heat transfer mechanisms, *International Journal of Multiphase Flow* 35 (2009) 1067–1076.
9. Leong K.C., Ho J.Y., Wong K.K.: A critical review of pool and flow boiling heat transfer of dielectric fluids on enhanced surfaces, *Applied Thermal Engineering* 112 (2017), 999–1019.
10. Shah M.M.: Unified correlation for heat transfer during boiling in plain mini/micro and onventional channels, *International Journal of Refrigeration* 74 (2017), 606 – 626.
11. Takamatsu H., Momoki S., Fujii T.: A correlations for forced convective boiling heat transfer of pure refrigerants in a horizontal smooth tube. *Int. J. Heat Mass Transfer* 1993, Vol. 36, No 13, pp. 3351.
12. Yang Z., Peng X.F., Ye P.: Numerical and experimental investigation of two phase flow during boiling in a coiled tube, *Int. J. Heat Mass Transfer* 51 (2008) 1003–1016.

Biographical note



Tadeusz Bohdal is a graduate of the Higher School of Engineering in Koszalin (now Koszalin University of Technology). Since 01.09.1976 he is an employee of Koszalin Unive rsity of Technology. Currently employed as a full professor, he is the Head of the Power Engineering Department at the Faculty of Mechanical Engineering.

His main specialty is the widely understood thermal and refrigeration technology. Educational, research and implementation activities cover theoretical and applied issues in conventional power engineering and the acquisition and processing of energy from renewable sources, the rational use of energy, the improvement of the efficiency of machinery and energy equipment, the search for new insulating materials and materials which well-conductive heat. He conducts scientific and research works on the boiling and condensing of new pro-ecological refrigerants. This applies in particular to heat transfer and flow resistance in two-phase systems in steady and unstable states. He is the author of more than three hundred and fifty scientific and technical publications (domestic and foreign), ten books and more than a hundred documented studies for business entities. He has been the manager of six grants, has promoted eight doctors, he is an author of numerous reviews of qualification works, research grants and research papers, as well as conference proceedings. He is also the author of 4 monographs and 9 national patents.